

●●● STUFF STEPH DOES



A FREE template for personal use.

Use this as a guide to make your own pillow or other creative endeavor, but please credit me and link back to my site if you post your creation online.

This template is made for an 18"x18" pillow (finished size), simply print all the pages at 100% and you'll be good to go!

Questions? Comments? I'd love to hear from you!
email me: [stuffstephdoes \[at\] gmail \[dot\] com](mailto:stuffstephdoes@gmail.com)

TEMPLATE LAYOUT

Cut out the following numbered pieces and lay them out on your fabric like this:

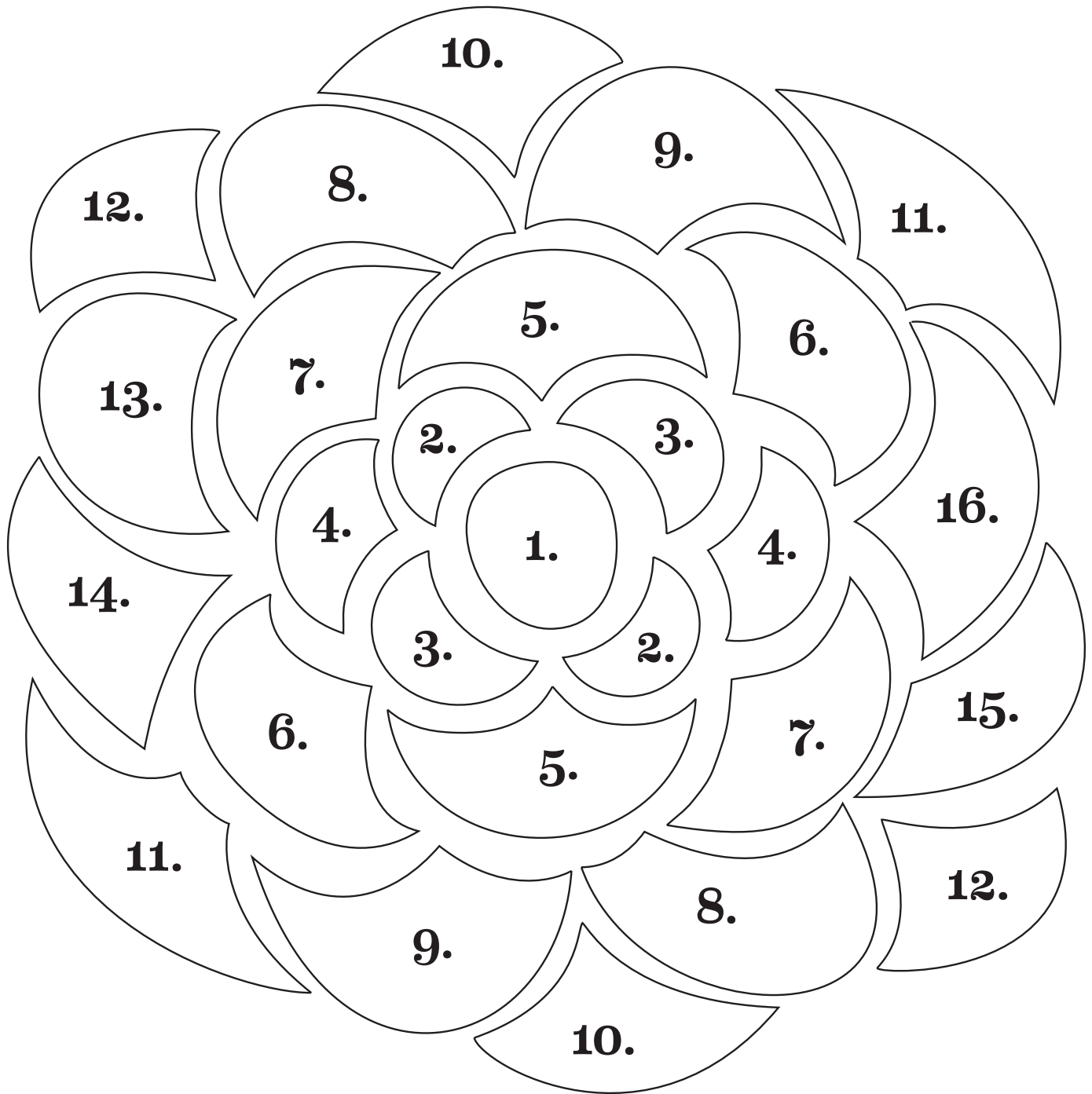

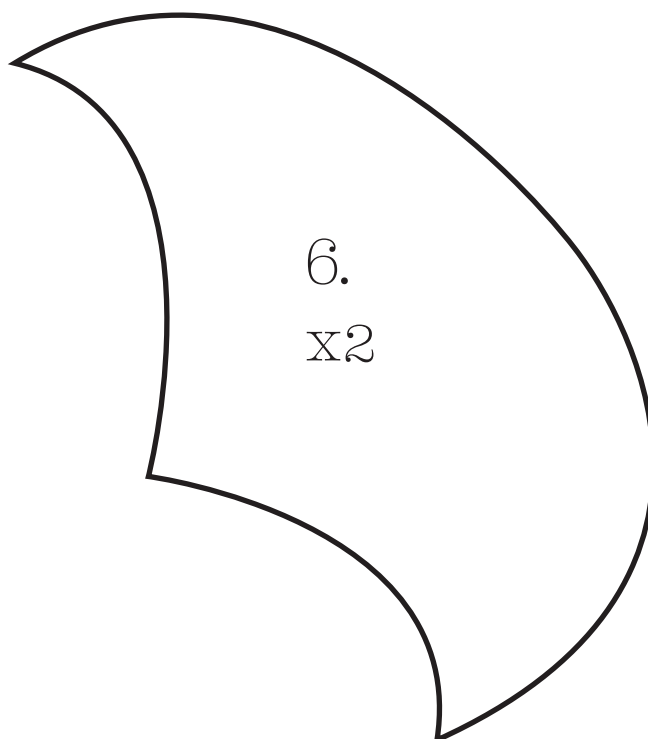
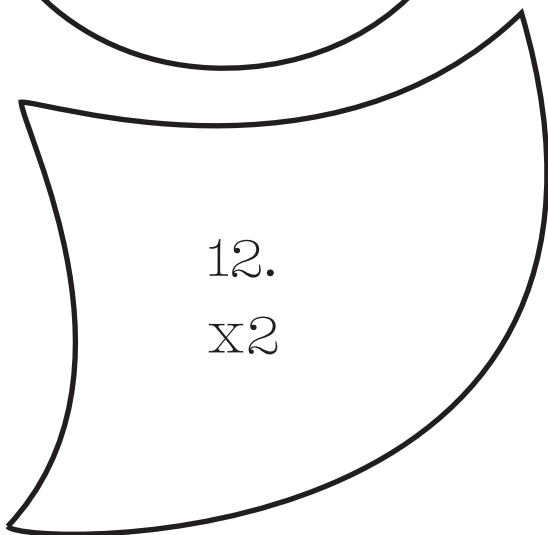
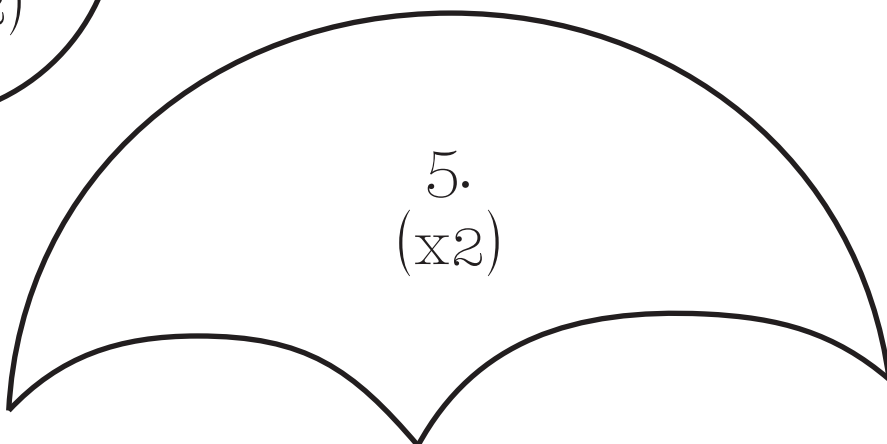
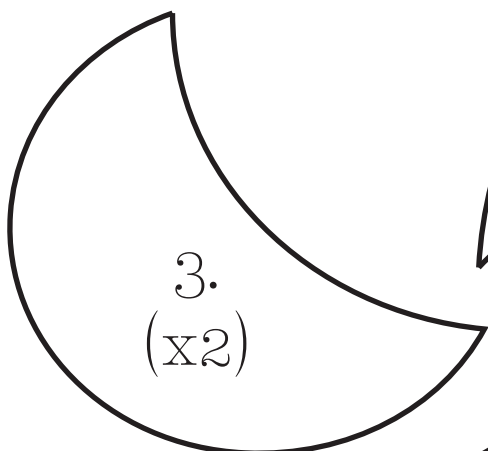
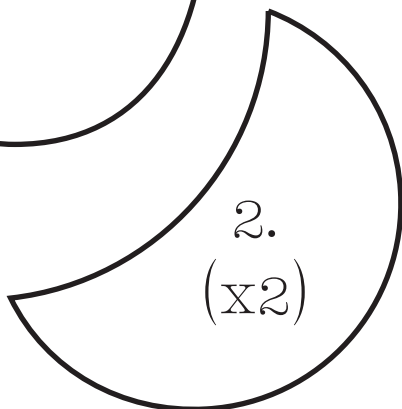
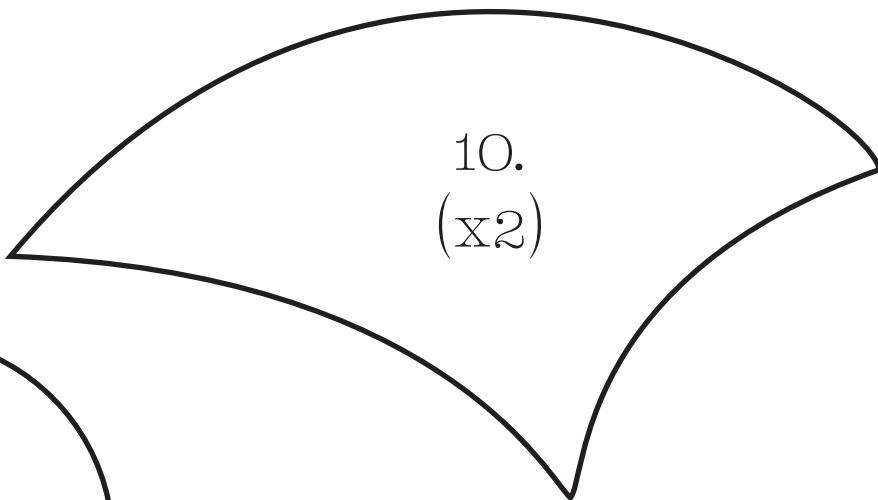
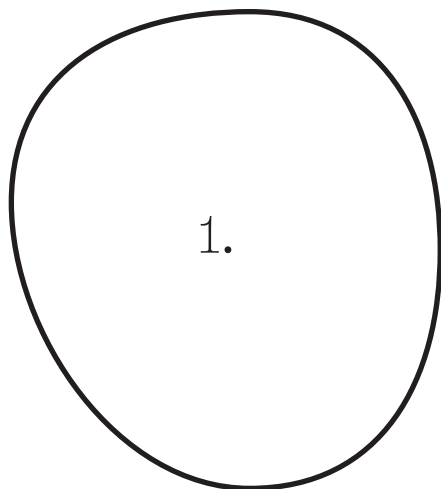

CUT OUT THESE PIECES!

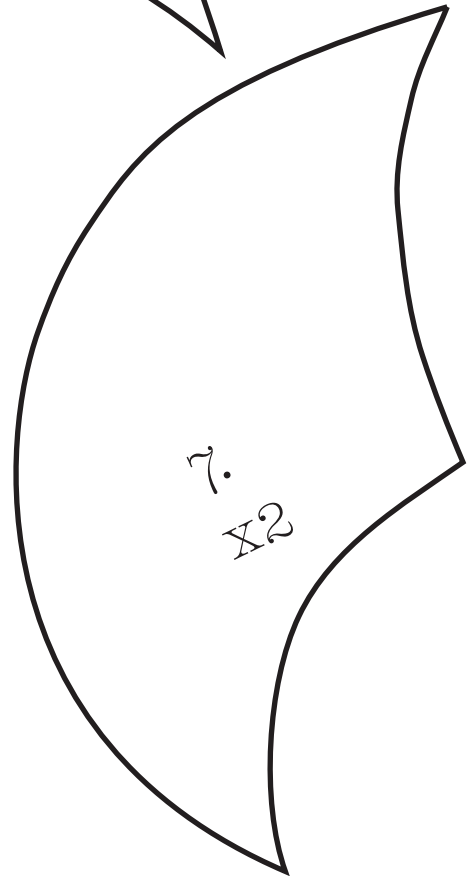
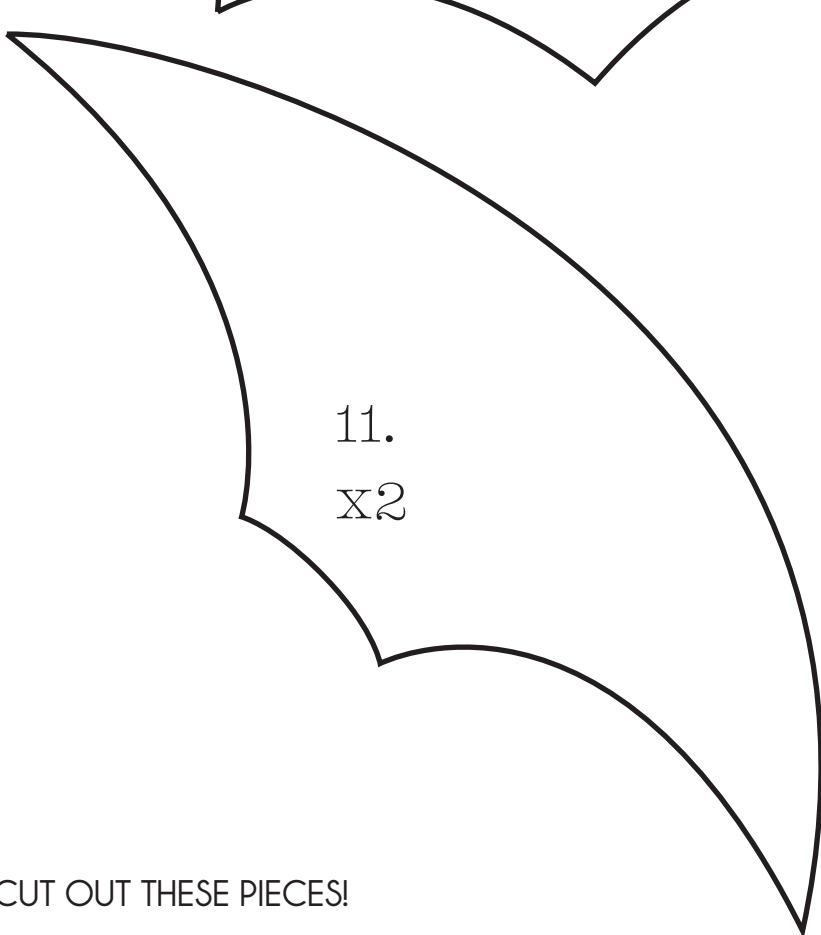
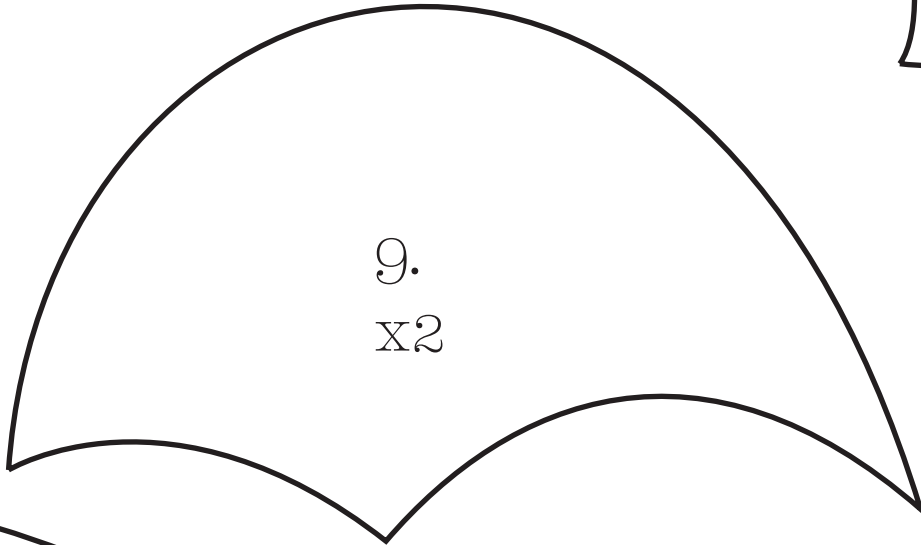
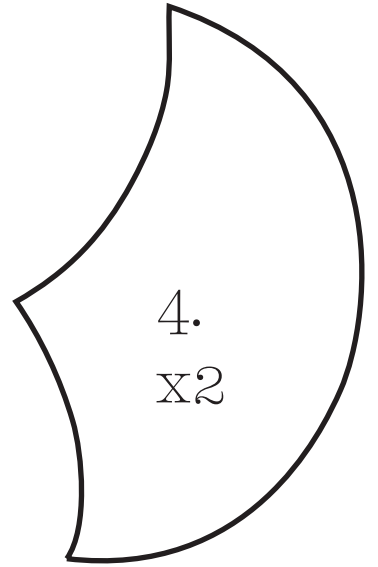
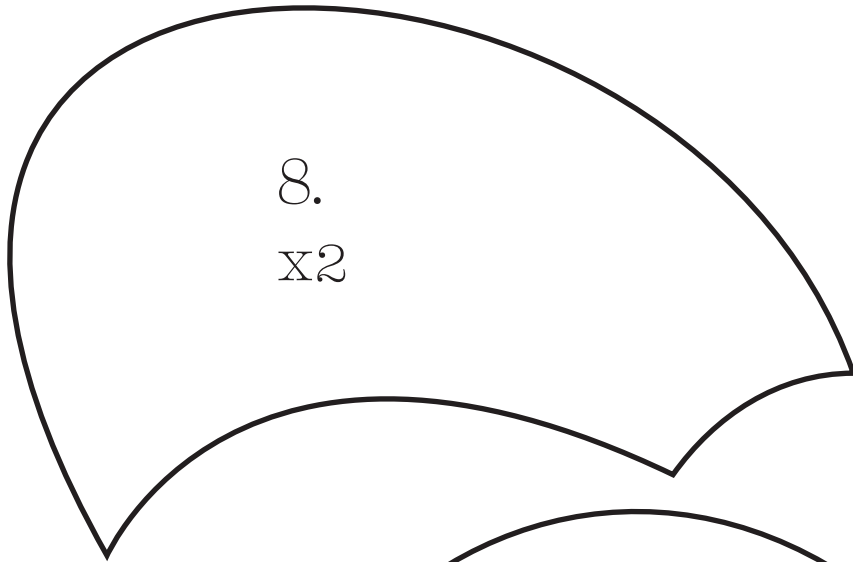

CUT OUT THESE PIECES!

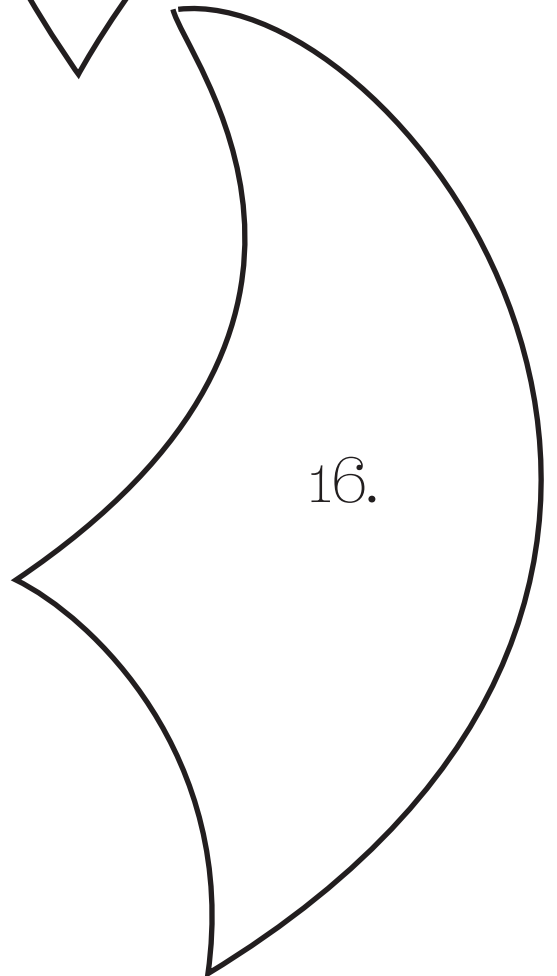
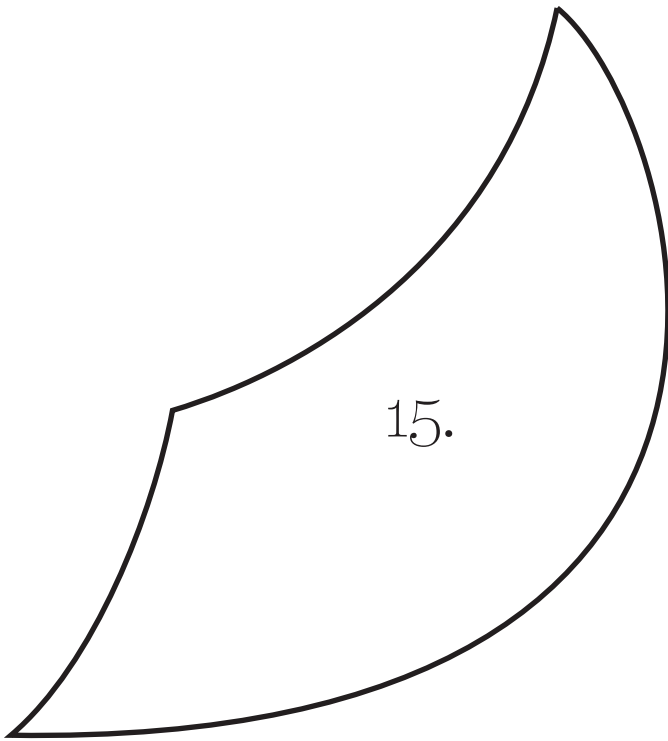
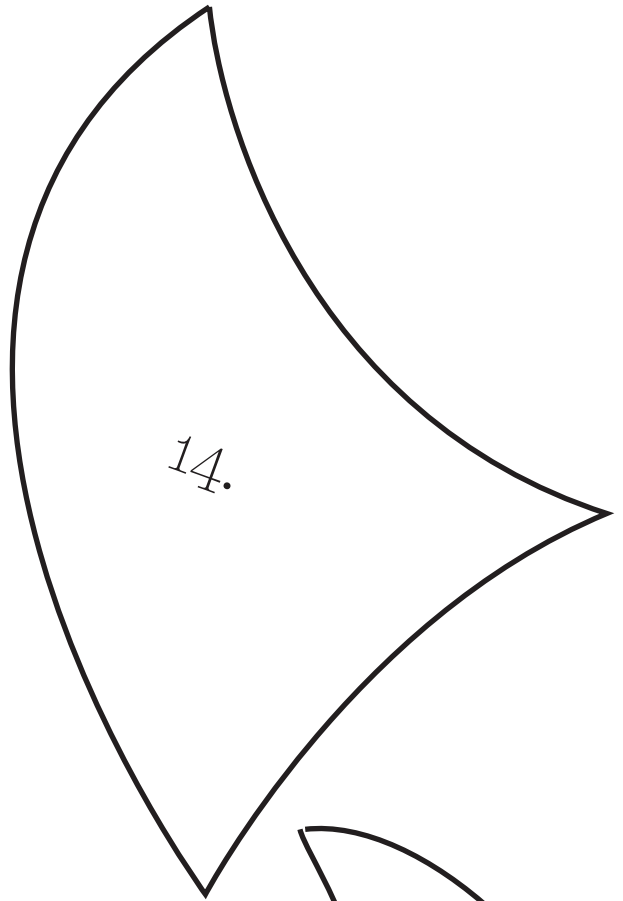
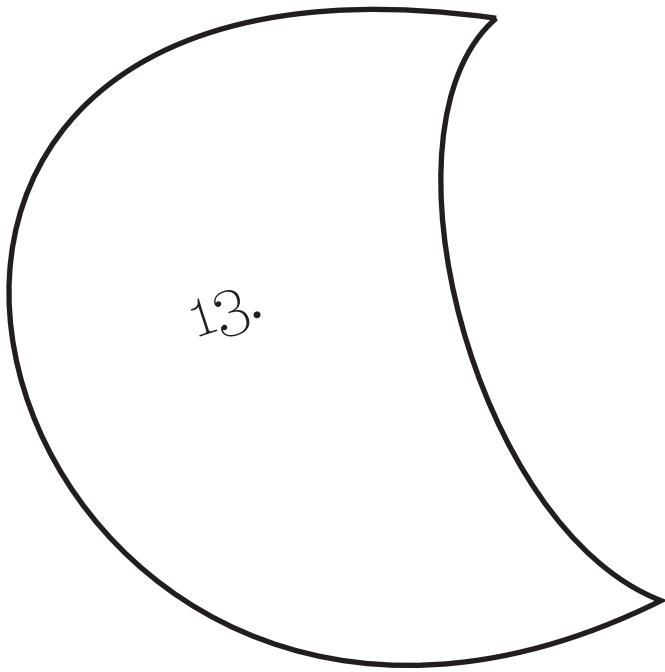

CUT OUT THESE PIECES!